



Furniture

QuickGroup

Quick Group, international leader in the design, production, and sale of nautical equipment and complex integrated systems for yachts and superyachts, operates in more than 110 countries worldwide.

From the beginning, the Group has stood at the forefront of technological advancement, pursuing an ambitious goal: to promote a short, sustainable, and entirely Made in Italy supply chain, aimed at enhancing the pleasure of boating through cutting-edge integrated solutions.

This vision is embodied by six iconic and technologically advanced brands - MC², Sanguineti, Quick Nautical Equipment, Quick Marine Lighting, Xenta, and Nemo - each representing the highest expression of Italian excellence and innovation.

Headquartered in Ravenna, with three production sites in Italy and logistics and commercial branches in the United States and the United Kingdom, Quick Group continues to strengthen its position as an international benchmark for innovation, quality, and reliability, a true hub of excellence for the nautical sector.

The Group has been working in partnership since 2022 with Fondo Italiano d'Investimento SGR and Armònia SGR.

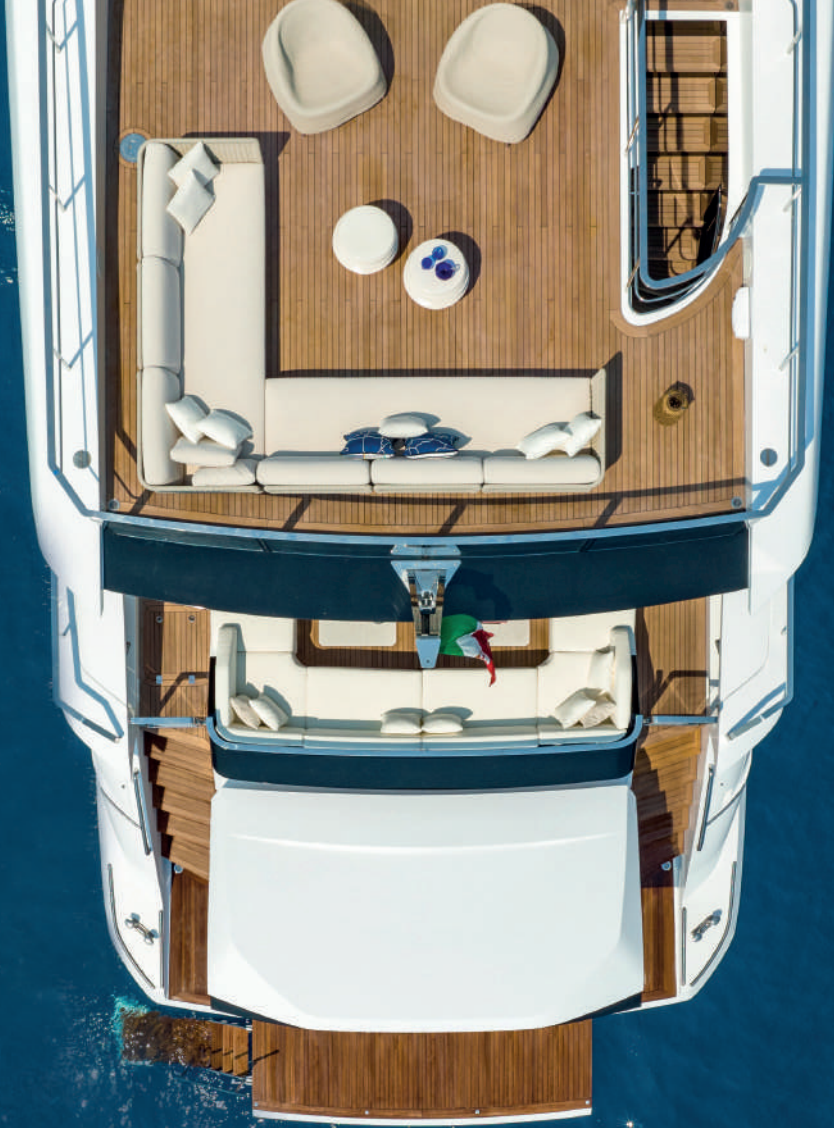



Sanguineti began its journey in 1958 as a small artisan workshop.

Over the decades, it has grown successfully, earning a considerable reputation in the market.

For over 65 years, Sanguineti has been a benchmark in the superyacht market, with entirely Italian production of hydraulic and electric motion systems, including gangways, ladders and platforms.

Combining tradition and innovation to address the needs of the nautical sector, creating exclusive projects for yachts, superyachts, and top-quality refits.

Today, as part of Quick Group, it is internationally recognized for its unwavering commitment to quality and innovation, blending traditional craftsmanship with modern technology to meet the evolving needs of the yachting world.

THE ART OF ITALY

Tradition and continuous investments allowed Sanguineti to establish in the world-wide market, addressing the needs of the nautical sector, becoming a state-of-the-art engineering brand.



IAN MAKING





SANGUINETTI



Furniture

Sanguineti also entered the nautical furnishing industry, gaining significant worldwide recognition since the creation of its iconic Karin wood chair.

Karin furniture series, made of selected wood, is completed with folding chairs and stools, available in mahogany and teak finishing.

Over the years the furniture line by Sanguineti was further enhanced by the iconic Smeralda series.

The light alloy structure is what definitively identifies the Smeralda.

This furniture line includes folding chairs and stools.

In both series, the seat and backrest are made of canvas and are available in various colors.



KARIN

Wooden Series

Karin is a easy folding chair and stool made from selected wood. Available in mahogany and teak finishing, seat and backrest are made of canvas.

KARIN

Finishes and Fabrics Options

STRUCTURE



Solid beech

FINISHES



Mahogany



Teak

STANDARD FABRICS

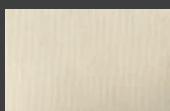

Natural
5020



Marine blue
5031

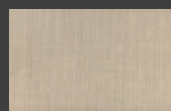

Oyster
5030

SPECIAL FABRICS

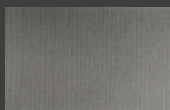

Cadet grey
5530



Fjord
P093



Flax
P017



Moonstone
P081

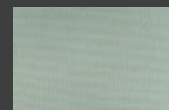

Glacier
P092





KARIN Chairs

Design Arch. Caliarì

TECHNICAL DRAWINGS

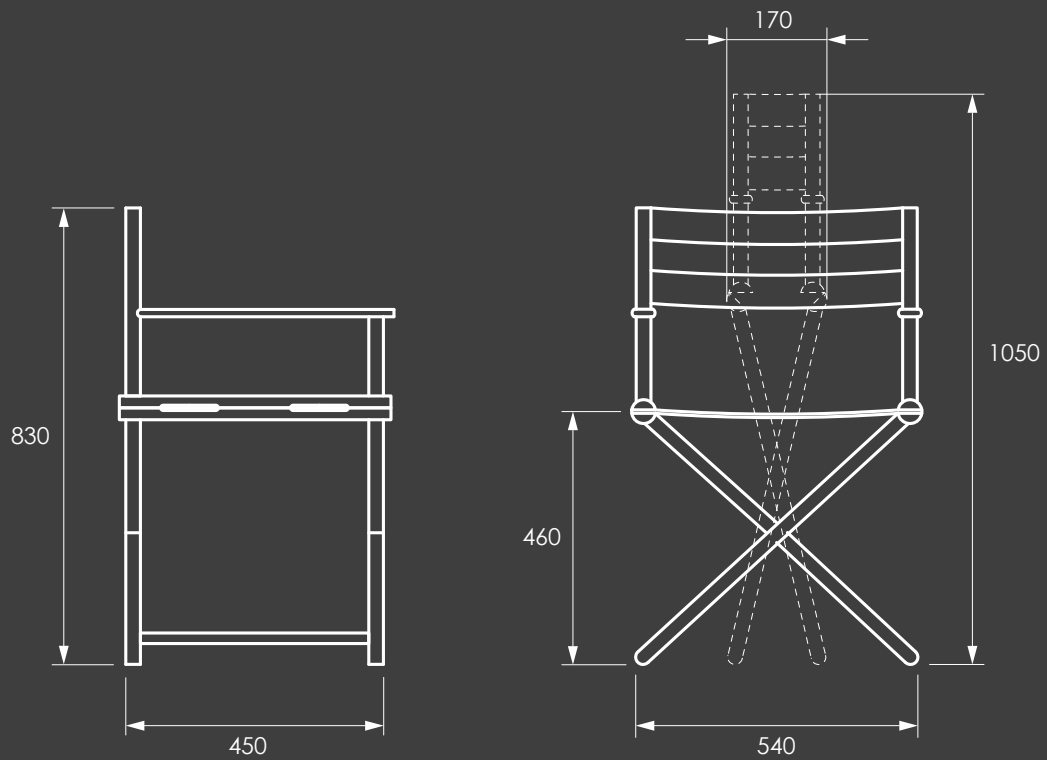



MAVE
by
QuickC





SMERALDA

Aluminum Series

Smeralda is a easy folding chair and stool made of light alloy. The removable covers are realized with outdoor fabric.

SMERALDA

Finishes and Fabrics Options

STRUCTURE

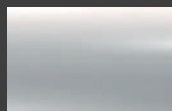

Light alloy

FINISHES

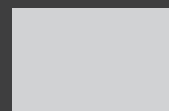

Silver



Black

STANDARD FABRICS

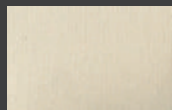

Natural
5020



Captain Navy
5057

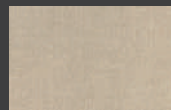

Oyster
5030

SPECIAL FABRICS



Fjord
P093

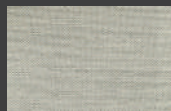

Marble
P052

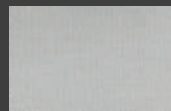

Silver
5035



Charcoal grey
5049

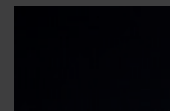

Jet black
5032

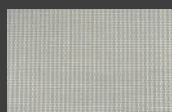

Howlite
P080





SMERALDA Chairs

Design Versari

TECHNICAL DRAWINGS

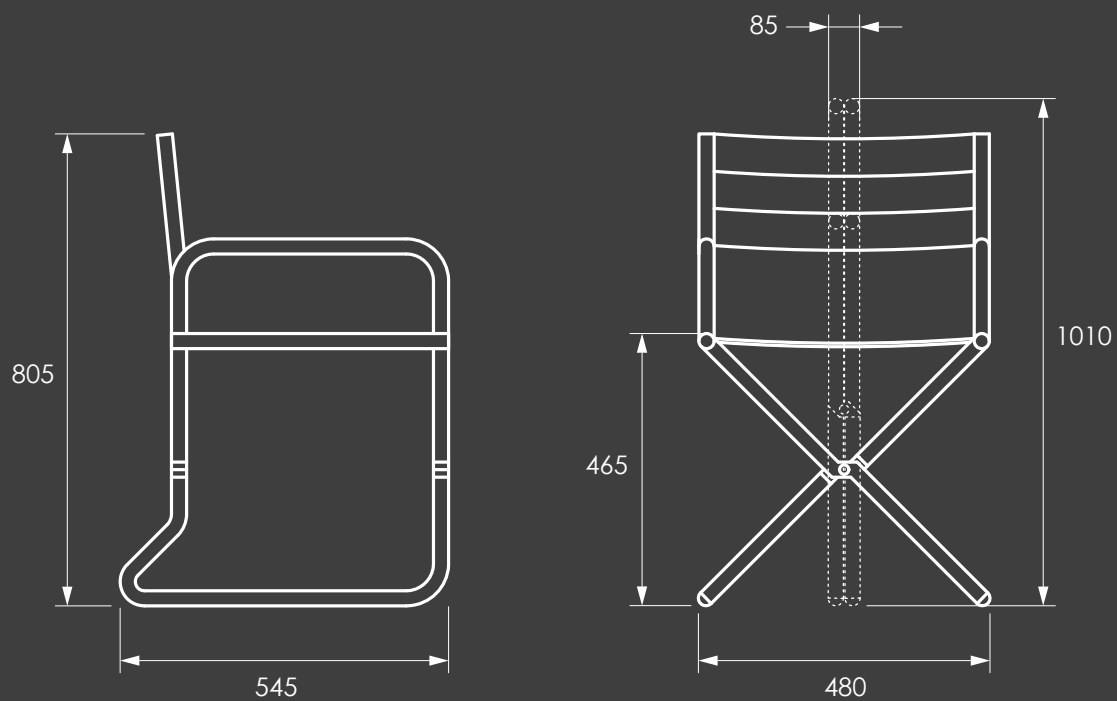

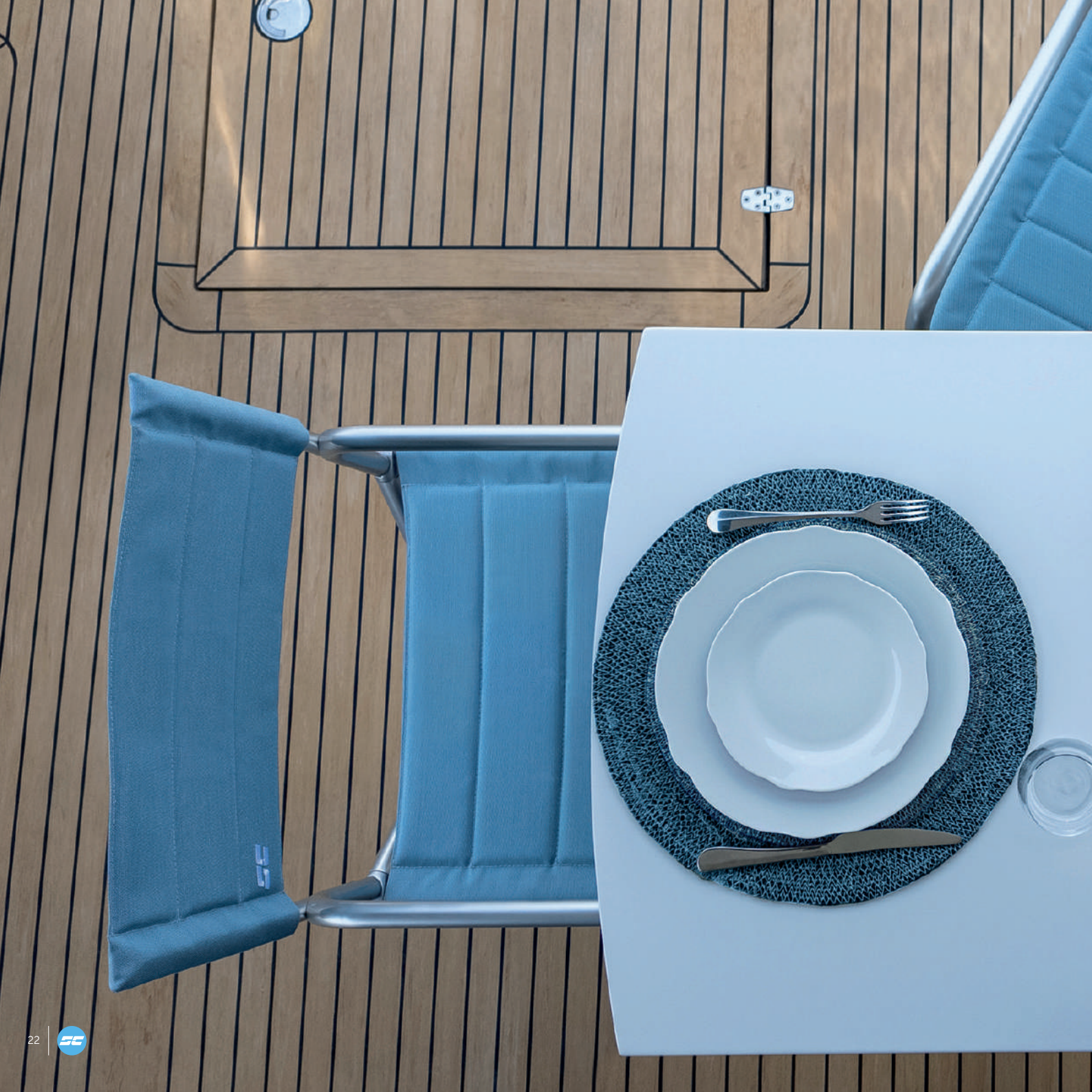





Company subject to the management and coordination of Quick S.p.A.
Via Alcide De Gasperi 37/Q – 16030 Casarza Ligure (GE) Italy
Phone: +39 0185 363324
www.sanguineti.com
info@sanguineti.com

CDBRSGTF0R02
October 2025

QuickGroup

Via Piangipane 120/A - 48124 Piangipane (RA) ITALY - Tel. +39 0544 415061 - www.quickgroup.com

mc²

Quick[®]
Nautical Equipment

 SANGUINETI

 XENTA

 nemo

Quick[®]
Marine Lighting